

Work happily



V1.3

naggura'swop

naggura.com

Our products



The Swop S3 Starter Spa is an electrical 3-section table with a one-piece mattress and wooden structure.

Wood, Metal or Pmma



Collections

Nordic
METAL

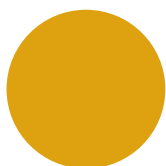

Yellow

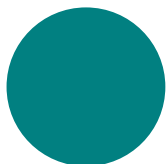

Blue

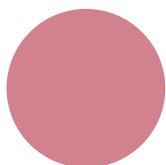

Pink

Foll
METAL

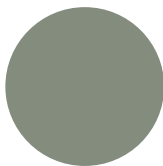

Ash

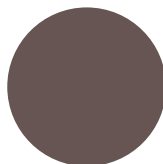

Clay

Iron
METAL

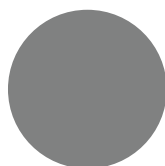

Inox



Black

Om
WOOD



Oak



Wenge

Techno
PMMA



Fluor



Fuxia



Ice

SWOP S3 STARTER SPA



Dimensions

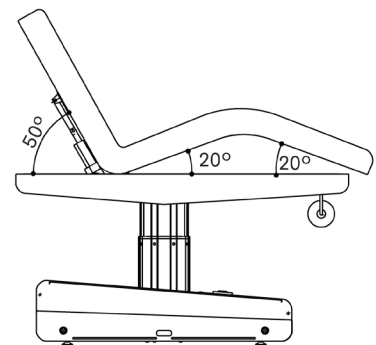
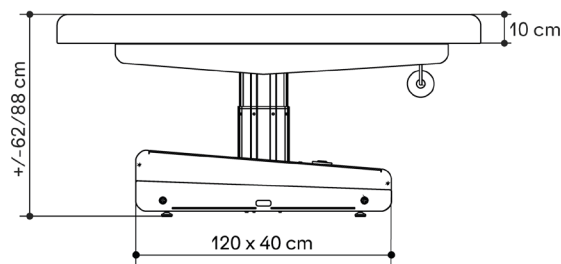
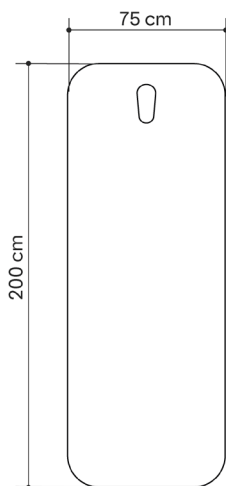

General specifications

MOTORS

3 engine (height, footrest, backrest)

DIMENSIONS (LENGTH X WIDTH)

200 x 75 cm

HEIGHT (MIN. AND MAX.)

62/88 cm

WEIGHT

110 kg

THICKNESS

10 cm

DENSITY

30 kg/m³

LIFTING CAPACITY

175 kg

OPERATION

Hand controller (included)/
Foot controller (optional)

POWER SUPPLY

230 V - 50/60 Hz

MAX. INTENSITY

2 A

ELECTRIC MOTOR

6.000 N

WARRANTY

2 years on table and
upholstery

CUSHION

Upholstery Seamless
round edges.

Naggura Skin upholstery:
100% vinyl compound in
white.

Superior abrasion resis-
tance: >250.000 cycles.
Protection against germs
and UV rays.